

# 23 Series Photo-MOSFET Relay

- **Features:** Low Capacitance Photo MOSFET Relay, switching up to 250V DC or Peak AC
- **SOP;** Low Off-State Leakage Current; Low Output Capacitance; UL listed
- **Applications:** Automatic Test Equipment, I/O Modules, Telephone Equipment
- **Markets:** Telecommunication, Test & Measurement, Security

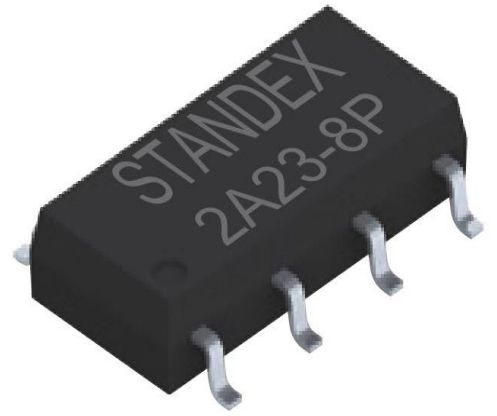

Part Description: **SMP-XA23-XPX-X**

Number of Poles	Contact Form	Series Number	Number of Pins	Mounting Type	Package Style	Special Features
1, 2	A	23	4, 8	P	Tube, Reel	Nil

See page 5 for Glossary

### Maximum Ratings @ Ambient Temperature = 25°C

Parameters	Symbol	Value		Units	Condition
		1A23-4P	1A23-8P		
<b>INPUT SPECIFICATIONS</b>					
Continuous LED Current	$I_F$	50	50	mA	-
Peak LED Current	$I_{FP}$	500	5	mA	f=100Hz, 1% Duty Cycle
LED Reverse Voltage	$V_R$	5	500	V	-
Input Power Dissipation	$P_{IN}$	75	75	mW	-
<b>OUTPUT SPECIFICATIONS</b>					
Load Voltage	$V_L$	250	250	DC or Peak AC	-
Load Current	$I_L$	170	140	mA	-
Peak Load Current	$I_{PEAK}$	420	420	mA	1 ms, 1 shot
Output Power Dissipation	$P_{OUT}$	300	450	mW	-
<b>GENERAL SPECIFICATIONS</b>					
Total Power Dissipation	$P_T$	350	50	mW	-
I/O Breakdown Voltage	$V_{I/O}$	1500	1500	$V_{RMS}$	-
Operating Temperature	$T_{OPR}$	-40/+85	-40/+85	°C	-
Storage Temperature	$T_{STG}$	-40/+100	-40/+100	°C	-



RoHS

REACH  
COMPLIANT

# 23 Series Photo-MOSFET Relay

## Maximum Ratings @ Ambient Temperature = 25°C

Parameters	Symbol	Min	Typ	Max	Units	Condition
<b>INPUT SPECIFICATIONS</b>						
LED Forward Voltage	$V_F$	1.0	1.17	1.5	V	$I_F = 10\text{mA}$
Operation LED Current	$I_{F\text{ ON}}$	-	0.6	3.0	mA	-
Recovery LED Voltage	$V_{F\text{ OFF}}$	0.5	1.0	-	V	-
<b>OUTPUT SPECIFICATIONS</b>						
On Resistance: Drain to Drain	$R_{\text{ON}}$	-	11	15	$\Omega$	$I_F = 5\text{mA}, I_L = \text{Rating (within 1 sec.)}$
Off-State Leakage Current	$I_{\text{LEAK}}$	-	0.1	10	nA	$V_L = 250\text{V}$
Output Capacitance	$C_{\text{OUT}}$	-	37	-	pF	$V_L = 0\text{V}, f = 1\text{MHz}$
<b>TRANSMISSION SPECIFICATIONS</b>						
Turn-On Time	$T_{\text{ON}}$	-	0.15	0.3	ms	$I_F = 5\text{mA}, I_L = \text{Rating}$
Turn-Off Time	$T_{\text{OFF}}$	-	0.05	0.2	ms	
<b>COUPLED SPECIFICATIONS</b>						
I/O Insulation Resistance	$R_{\text{I/O}}$	$10^9$	-	-	$\Omega$	-
I/O Capacitance	$C_{\text{I/O}}$	-	0.8	-	pF	$f = 1\text{MHz}$

## Photo-MOSFET Relay Dimensions (Tolerances acc. to ISO 2768-mp)

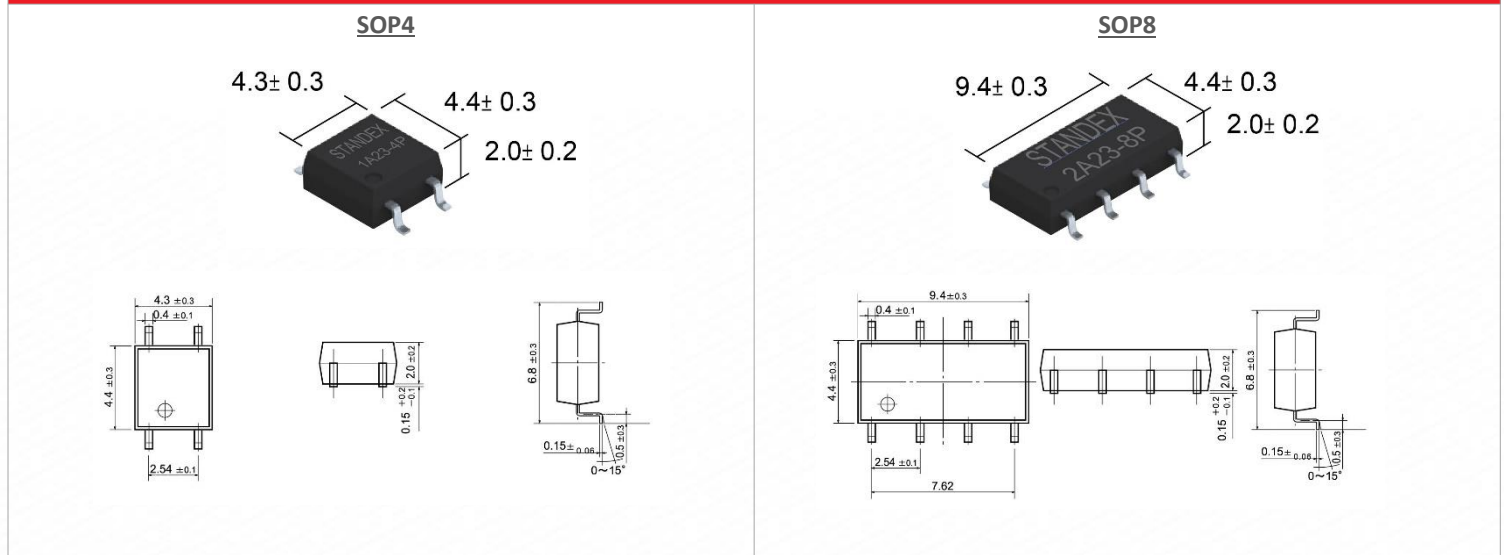

# 23 Series Photo-MOSFET Relay

## Photo-MOSFET Relay Pin-Out

**4-PIN**

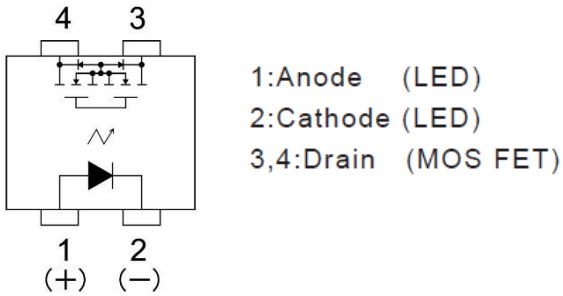

**8-PIN**

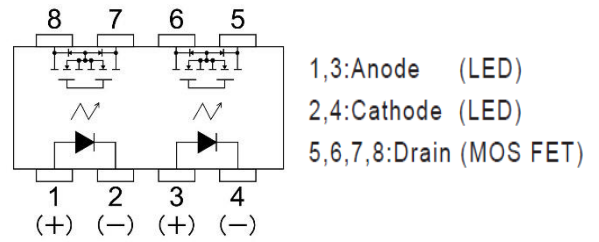

## Photo MOSFET Relay Recommended PCB Pad Layout (Tolerances acc. to ISO 2768-mp)

**SOP4 (Top View)**

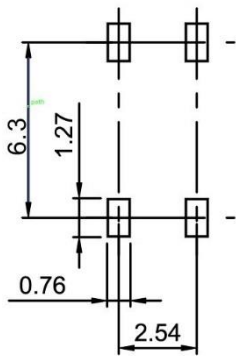

**SOP8 (Top View)**

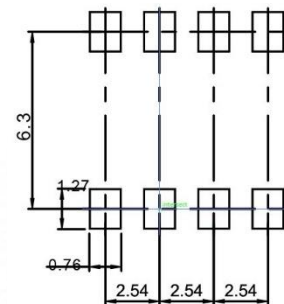

# 23 Series Photo-MOSFET Relay

## Photo MOSFET Relay Reference Data

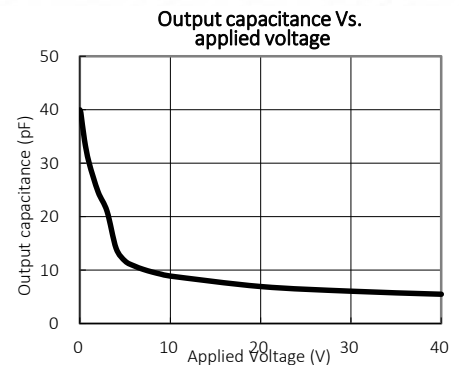
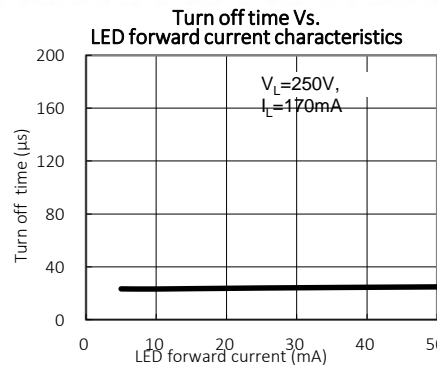
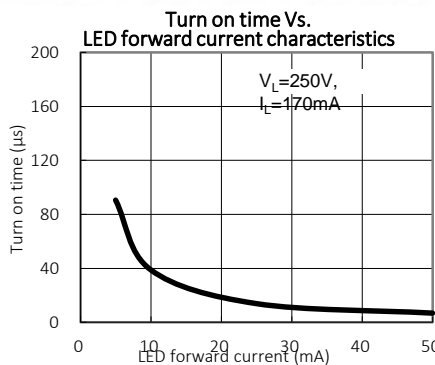
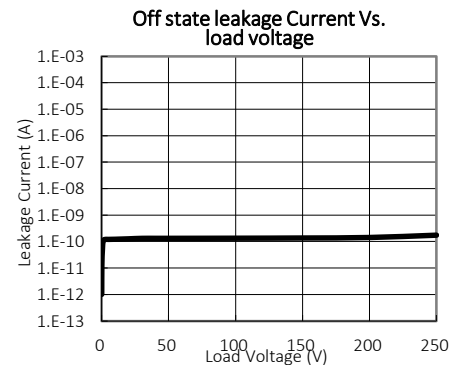
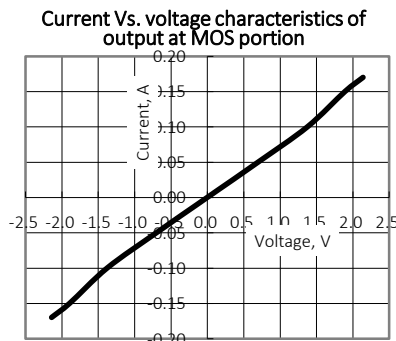
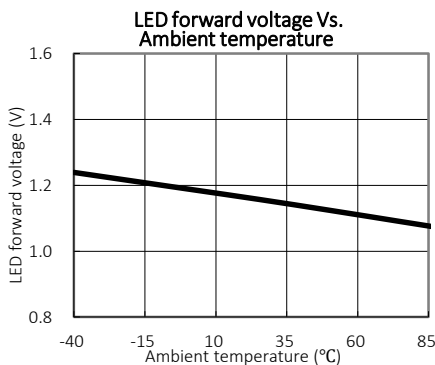
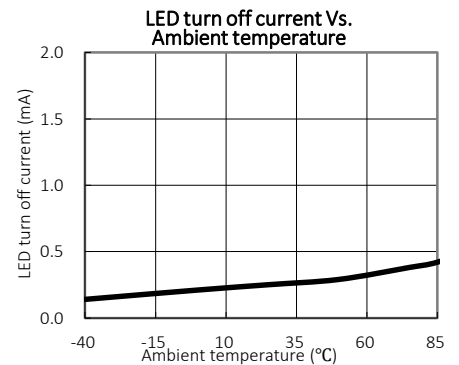
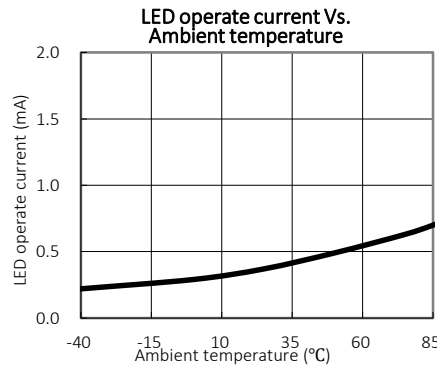
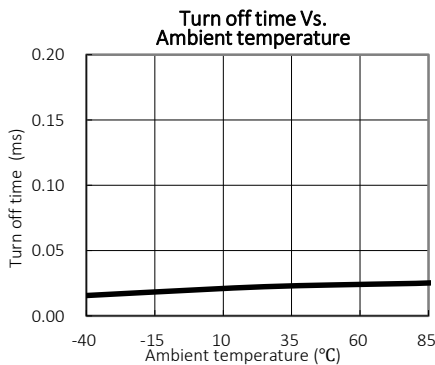
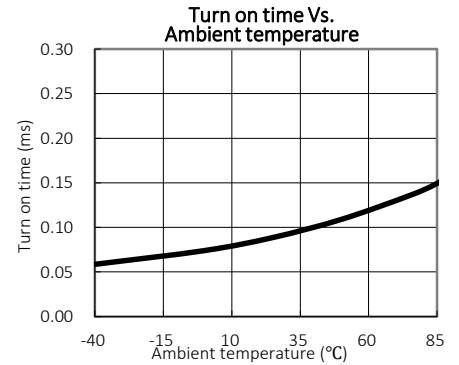
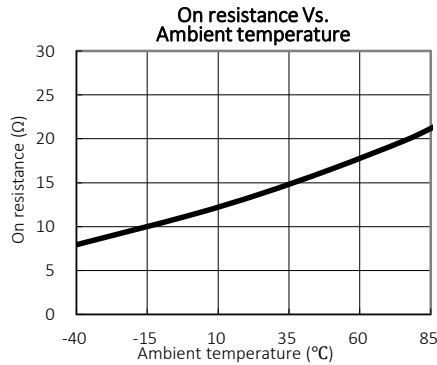
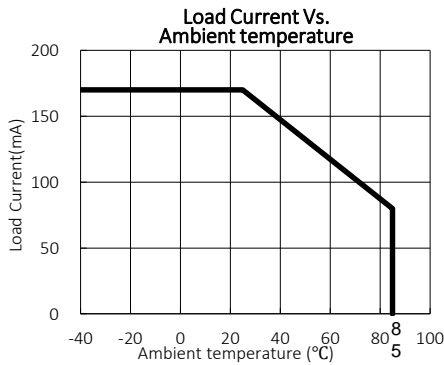

# 23 Series Photo-MOSFET Relay

## Photo MOSFET Relay Tape & Reel Packaging (1,000 pcs per reel)

### SOP4

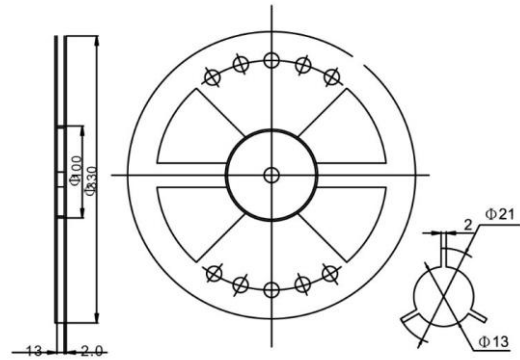
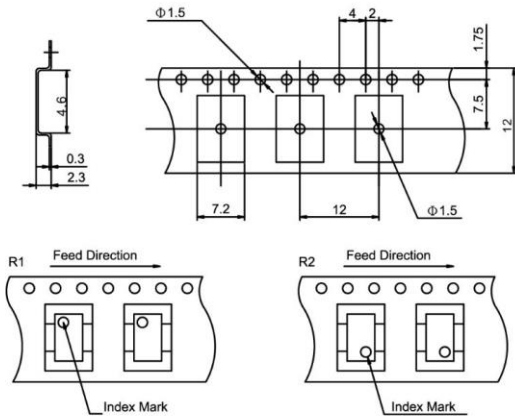

### SOP8

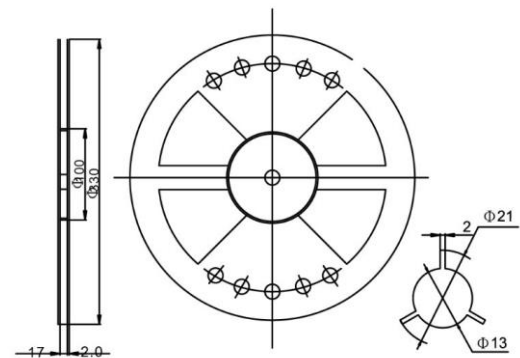
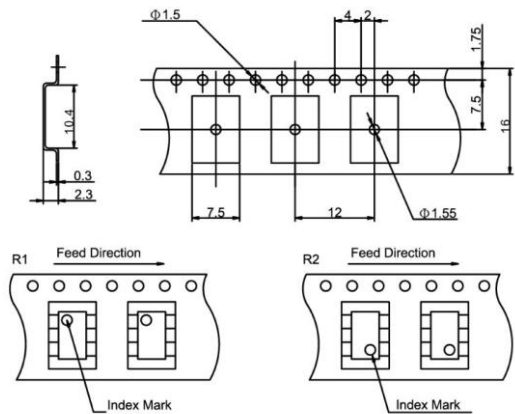

### Glossary Options

D	DIP (Dual-In-Line Package)
S	SMD (Surface Mount Design)
P	SOP (Small-Outline Package)
Q	AEC-Q101 / High Temperature
R	Reinforced Isolation

**Please note:** All technical specifications in this series datasheet refer to the standard product range. Modifications in the sense of technical progress are reserved. For general information only. For more specific information, please consult the product datasheet, available upon request.

This series datasheet could contain technical inaccuracies or typographical errors. Changes are periodically made to the information herein. These changes will be incorporated in future revisions.

For deviating values, latest specifications and product details, please contact your nearest sales office.